



Product Features

Types of Pella Windows and Doors W-PS-2
Minimum and Maximum Sizes W-PS-2

Product Line and Options

Brand Description W-PS-3
Brand Selection Guide W-PS-4
Grille Options W-PS-5
Between-the-Glass Window Fashions W-PS-7
Color and Coating Options W-PS-8

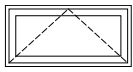

Awning

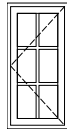

Casement

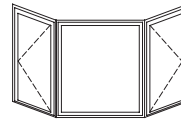

Bay and Bow

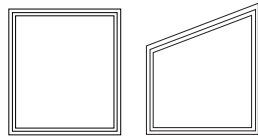

Rectangular/Angled Shapes

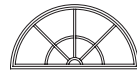

Curved

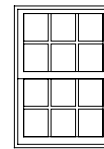

Double- and Single-Hung

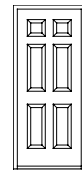

Entry Door System

FIXED FRAME DIRECT SET

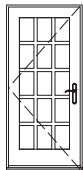

In-Swing Hinged Door

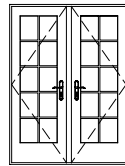

Out-Swing Hinged Door



Sliding Contemporary Door

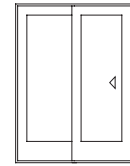

Sliding French Door

MINIMUM AND MAXIMUM SIZES

PRODUCT TYPE	FRAME WIDTH		FRAME HEIGHT	
	Minimum	Maximum	Minimum	Maximum
Awning Windows				
Operable Units	1' 5" (432)	4' 11" (1 498)	1' 5" (432)	4' 11" (1 498)
Bay and Bow Units				
Operable Units	See Casement and Double-Hung Frame Sizes			
Casement Windows				
Operable Units	1' 5" (432)	2' 11" (889)	1' 5" (432)	6' 1" (1 854)
Fixed Frame Direct Set				
Non-Operable Curve Top Units	12" (305)	9' 0" (2 743)	10-1/2" (267)	8' 0" (2 438)
Non-Operable Rectangular/Angled	8" (203)	10' 0" (3 048)	8" (203)	10' 0" (3 048)
Hung Windows				
Operable Units	1' 1-3/4" (349)	5' 0" (1 524)	2' 4" (711)	10' 0" (3 048)
Entry Door Systems				
Operable Units	2' 9-1/2" (851)	3' 1-1/2" (953)	6' 9-1/2" (2 070)	8' 1-1/2" (2 477)
In-Swing Hinged Doors				
Operable Units	2' 1-3/8" (645)	6' 3-1/16" (1 907)	6' 8-1/8" (2035)	7' 11-1/2" (2 426)
Out-Swing Hinged Doors				
Operable Units	2' 1-3/8" (645)	5' 11-1/4" (1 810)	6' 8-1/8" (2 035)	7' 11-1/2" (2 426)
Sliding Doors				
Operable Units	4' 11-1/4" (1 505)	15' 8-1/8" (4 778)	6' 8-1/8" (2 035)	7' 11-1/2" (2 426)

Figures in parentheses following or adjacent to dimensions are International (metric) equivalents in millimeters. For metric equivalents other than those shown, multiply dimensions in inches by 25.4. Larger sizes on select units are available on a custom basis.



Architect Series®

products feature grilles permanently bonded to the interior and exterior glass. These Integral Light Technology® grilles replicate the historically correct appearance of true divided light while providing state-of-the-art energy efficiency, structural integrity and water-resistant performance.

- Standard Advanced Low-E insulating glass with argon, for reduced fading and lower heating and cooling costs. Optional, uncoated insulating glass, HurricaneShield® products with impact-resistant glass, tinted and custom glazing are also available.
- Permanently bonded grilles available in virtually unlimited pattern options.
- An insulating non-glare spacer is installed between the glass panels and underneath the grilles. This replicates the appearance of true divided light—with thermal performance superior to that of competitors' metal spacers.
- Optional removable room side grilles or permanently installed aluminum grilles-between-the-glass are also available.
- Aluminum-clad or wood exteriors.
- Custom cladding colors. Choice of standard colors or a virtually infinite range of custom colors.
- Wood interiors are available unfinished, factory primed, factory prefinished White, Linen White, Bright White or factory prefinished stain.
- Windows are built to order in 1/4" increments.

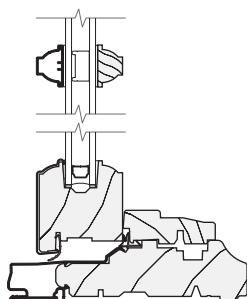

Architect Series with 7/8" Regular Integral Light Technology Grilles

Designer Series®

products feature our exclusive between-glass blinds, fabric shades, decorative panels and grilles that snap in and out easily, making them a unique solution for any project. Window treatments under glass function as an integrated environmental control system. Dust and allergens are reduced, less maintenance is needed, and cordless blinds and shades are safer for children and pets.

- Optional Low-E insulating glass with argon, for reduced fading and lower heating and cooling costs.
- Between-glass window fashions, decorative panels and grilles—protected from dust, damage and busy hands—can greatly reduce long-term maintenance costs.
- Double- and triple-pane glazing offers space for two between-glass options.
- Exterior aluminum cladding.
- Custom cladding colors. Choice of standard colors or a virtually infinite range of custom colors.
- Wood interiors are available unfinished, factory primed, factory prefinished White, Linen White, Bright White or factory prefinished stain.
- Windows are built to order in 1/4" increments.
- Between-glass grilles are removable; exterior matches cladding color, interior is unfinished wood, primed, stain matched or white. Several standard patterns with special patterns available.

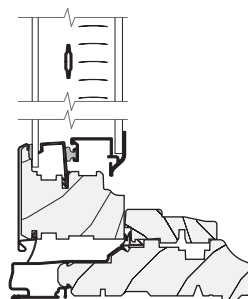

Designer Series Double-Pane Glazing, with Removable Between-Glass Grilles and Slimshade Blinds

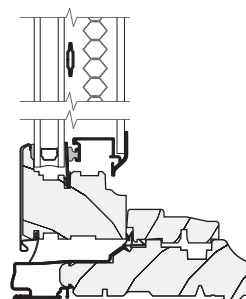

Designer Series Triple-Pane Glazing, with Removable Between-Glass Grilles and Cellular Fabric Shades

Pella® ProLine

price is important, and you don't want to sacrifice quality and performance, Pella ProLine windows and doors are the ideal solution. ProLine products deliver the quality assurance and energy efficiency of Pella windows—and a virtually low-maintenance exterior.

- Optional Advanced Low-E insulating glass with argon, for reduced fading and lower heating and cooling costs. Standard, uncoated insulating glass available on white-clad windows only.
- Three grille options are available: removable wood interior grilles with a real wood, beveled profile; permanently installed aluminum grilles-between-the-glass; or grilles permanently bonded to the interior and exterior of the insulating glass simulating a divided light appearance.
- Exterior aluminum cladding available in White, Tan, Brown, Poplar White, Putty, Hartford Green, Black and Brick Red.
- Wood interiors are available unfinished, factory primed, factory prefinished White, Linen White, Bright White or factory prefinished stain.
- Standard sizes available.

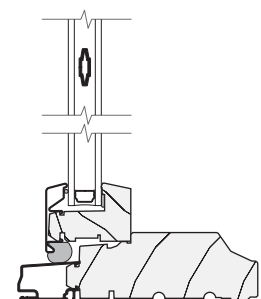

Pella® ProLine with Grilles-Between-the-Glass



OPTIONS AND ACCESSORIES

	Architect Series*	Designer Series*	Pella® ProLine	Fixed Frame Direct Set
GRILLES				
Integral Light Technology®	●	–	–	●
Removable Between-the-Glass	–	●	–	–
Removable Interior Pine Wood	●	–	●	●
Simulated Divided Light	–	–	●	–
Grilles-Between-the-Glass	● ₁	–	●	● ₁
WINDOW FASHIONS₂				
Between-the-Glass Slimshade® blinds	–	●	–	–
Between-the-Glass cellular fabric shades	–	●	–	–
Between-the-Glass decorative panels	–	●	–	–
INSECT SCREEN				
InView™ screens	●	●	●	–
Vivid View® (windows only)	●	●	●	–
Rolscreen® Retractable (Casement windows and Sliding Doors only)	●	●	–	–
GLAZING				
Insulated Glass Options / Low-E Types				
Advanced Low-E	●	●	●	●
NaturalSun Low-E	●	●	●	●
SunDefense™ Low-E	●	●	●	●
SunDefense™ Dual Low-E	●	●	●	●
Designer Series® with Low E HGP	–	●	–	–
Clear (no Low-E coating)	●	●	●	●
Additional Glass Options				
Annealed Glass ₃	●	●	●	●
Tempered Glass	●	●	●	●
Obscure Glass	●	●	●	●
Tinted Glass (Bronze, Gray and Green)	●	●	–	●
Pattern	●	●	–	–
Spandrel Glass	–	–	–	●
Laminated Insulating Glass	●	● ₃	–	●
Hurricaneshield® products with Impact Resistant Insulating Glass	●	–	–	●
Reflective	●	–	–	●
Glazing Type				
Dual IG	●	●	–	●
Designer Series® triple pane glazing	–	●	–	–
Glazing Type				
Argon	●	●	●	●
High Altitude	●	●	●	●
Argon High Altitude	●	●	–	–
INTERIOR WOOD TYPES				
Pine	●	●	●	●
Mahogany, Alder, Douglas Fir	●	–	–	●
EXTERIOR				
EnduraClad® Exterior - three standard colors	●	●	●	●
EnduraClad Exterior - feature and/or custom colors ₂	●	●	●	●
EnduraClad Plus Protective finish with - (70% fluoropolymer resin)	●	●	–	●
Primed or unfinished wood (Pine or Mahogany)	●	–	–	–
WINDOW SIZES				
Standard size and built to order in 1/4" increments	●	●	●	●
DOOR SIZES				
Standard size and built to order in 1/4" increments	●	●	●	–

(1) Available in select sizes and colors.

(2) Contact your local Pella sales representative for current designs and color options. ProLine has limited feature colors, see each product section in Volume 2 for information.

(3) This applies to windows only.



INTEGRAL LIGHT TECHNOLOGY® GRILLES

Historically accurate grilles, permanently affixed to the interior and exterior glass are available only on **Architect Series®** products. Wood grilles are adhered to the interior glass face and wood or extruded aluminum grilles are adhered to the exterior glass face. Interior and exterior grilles are aligned with a foam spacer between the two panes of glass. This replicates the appearance of true divided light and offers thermal performance vastly superior to competitor's metal spacers.

- Grille profiles are available in 7/8", 1-1/4" and 2" widths. Custom widths and patterns are also available.
- Curved members may have exposed finger-joints.

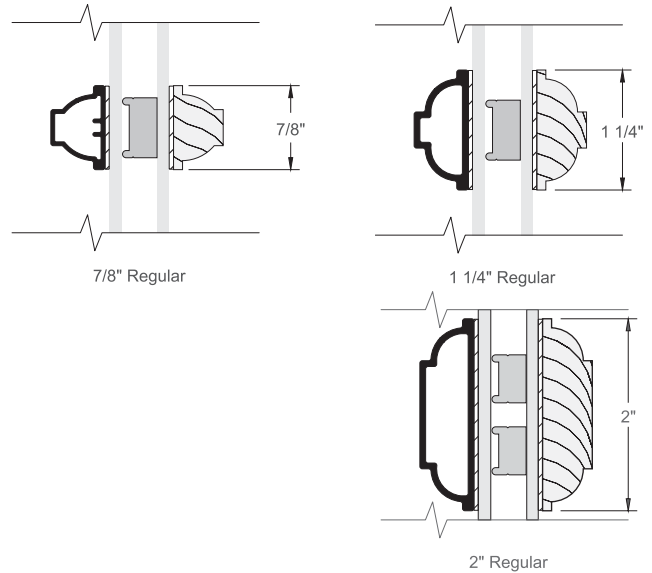

BETWEEN-THE-GLASS GRILLES

Removable grilles with wood on the room side and extruded aluminum to the exterior, mounted between the glass in **Designer Series®** double- and triple-pane glazed window and door systems. Between-glass grilles may be used in conjunction with between-glass Slimshade® blinds, cellular fabric shades, or decorative panels on all Designer Series products.

- Flat grille profiles are available in 3/4" width.
- Special patterns are also available.

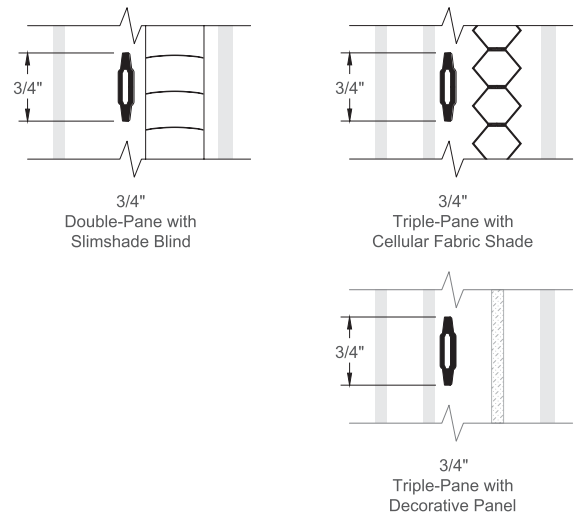

REMOVABLE INTERIOR GRILLES

Roomside pine wood grilles are securely attached to the interior.

- Available in 3/4", 1-1/4" and 2" regular and 1-1/4" and 2" Colonial profiles for **Architect Series**.
- 3/4" regular profile is available in **Pella® ProLine**.

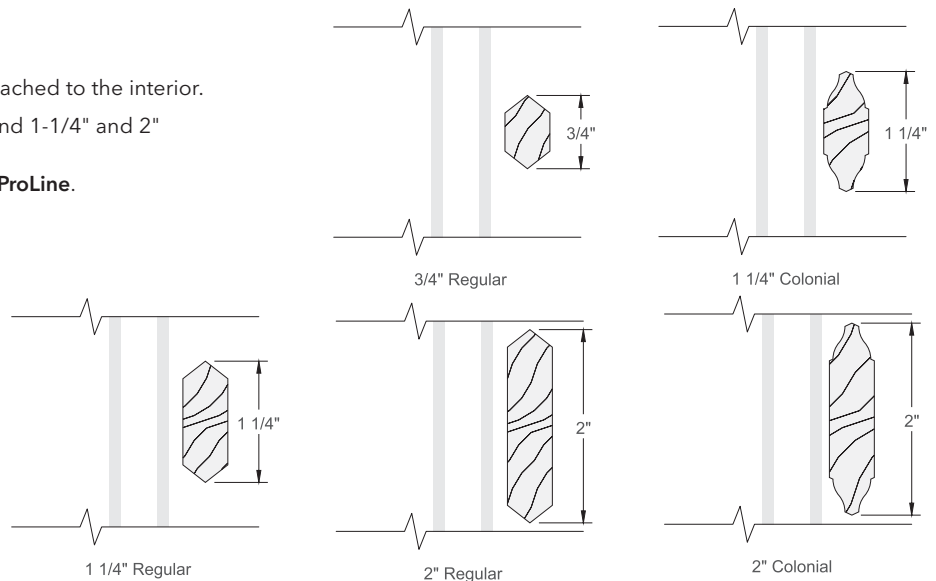



SIMULATED-DIVIDED-LIGHT

Wood grilles are adhered to the interior glass face and extruded aluminum grilles are adhered to the exterior glass face.

- Grilles are available in 7/8" profile.
- Available only in ProLine® windows.

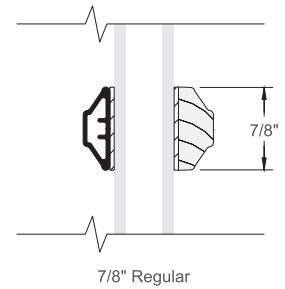

GRILLES-BETWEEN-THE-GLASS

Contoured 3/4" aluminum grilles sealed between the two panes of glass. Interior grilles are White, Tan¹, Brown¹, Ivory, Harvest, Cordovan or Brickstone. Exterior grilles match exterior cladding.

- Available in Pella® ProLine windows and doors, most Architect Series® windows and doors and select Entry Doors.

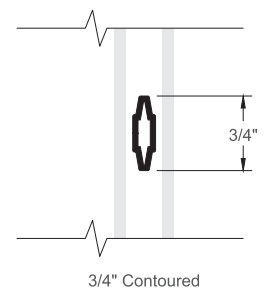

FIXED GRILLES

Permanently installed interior and exterior 7/8" fiberglass grilles built into the Entry Door glazing frame.

- Available only in select Entry Doors.

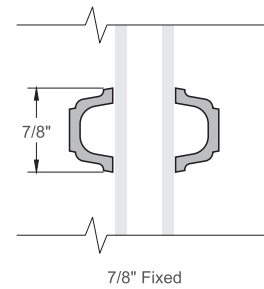

(1) Tan and Brown GBG colors are available in single-tone only (Brown on interior and exterior or Tan on interior and exterior).



The Designer Series® product line provides excellent opportunities to enhance user comfort and environmental control and to expand design versatility with between-glass blinds, fabric shades, and grilles. These products are a good choice for projects such as health care facilities and schools because the blinds and shades are protected from dust, germs and damage from tampering hands. That means your clients will save on cleaning and maintenance, as well as replacement hassles and costs. Plus, putting blinds between the glass not only gives a room a neat, clean appearance—it also creates additional display space for student artwork and graphics.

Available in Designer Series Casement, Awning, and Double-Hung Windows; plus Hinged and Sliding Doors.

DOUBLE-PANE GLAZING BETWEEN-THE-GLASS OPTIONS

A two-pane system with a 1-7/16" space between the exterior pane and interior hinged glass panel, providing room for grilles and between-the-glass blinds or cellular fabric shades.

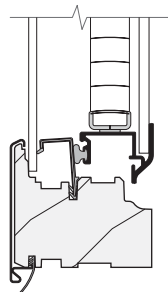

Raise and Lower
or Tilt only Blinds

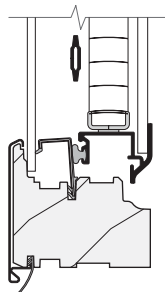

Grilles and
Raise and Lower
or Tilt only Blinds

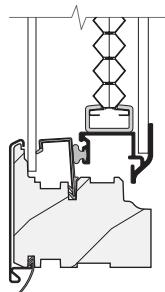

Cellular
Fabric Shades

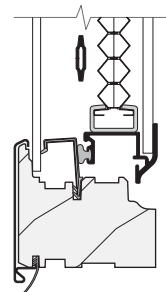

Grilles and Cellular
Fabric Shades

TRIPLE-PANE GLAZING BETWEEN-THE-GLASS OPTIONS

A three-pane system, which includes 1-3/32" space between the insulating glass and an interior hinged glass panel. The space between the insulating glass and hinged glass provides room for grilles and between-the-glass blinds, cellular fabric shades, or decorative panel.

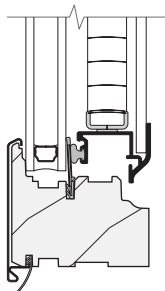

Raise and Lower
or Tilt only Blinds

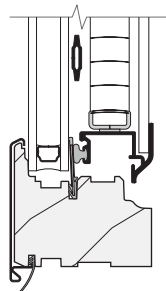

Grilles and
Raise and Lower
or Tilt only Blinds

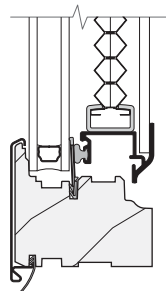

Cellular
Fabric Shades

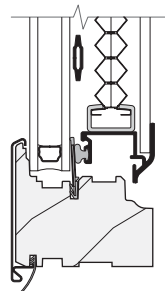

Grilles and Cellular
Fabric Shades

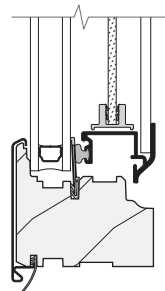

Decorative Panel

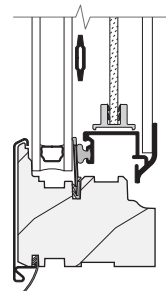

Grilles and
Decorative Panel



Whatever colors your design requires, Pella® windows and doors offer solutions to make it a reality. Our aluminum-clad exteriors can keep your vision fresh and crisp for years, resisting weather and abrasion with durable low-maintenance EnduraClad® exterior and EnduraClad Plus protective finish with 70% fluoropolymer resin multi-step, backed-on finish.

EXTRAORDINARY COLOR FLEXIBILITY

When it comes to selecting the aluminum cladding color you want for your project, Pella offers you a range of color options to match your design and budget requirements:

- Three standard colors: White, Tan and Brown.
- Feature color options¹
- Custom color² capabilities that can match virtually any color you select (nominal upcharge).

ENDURA CLAD PROTECTIVE FINISH

Our aluminum cladding with the Pella EnduraClad multi-step, backed-on finish delivers a cladding system with weatherability that resists fading and chalking. Providing a beautiful, low-maintenance exterior, the EnduraClad exterior will protect your design for years.

ENDURA CLAD PLUS PROTECTIVE FINISH

The EnduraClad Plus protective finish takes our EnduraClad exterior finish one step further—based on the superior weatherability of full-strength 70% fluoropolymer resin—not 50% PVDF resin—to ensure a significant increase in performance over our tough EnduraClad protective finish. Only finishes based on 70% fluoropolymer resin exceed the new AAMA 2605 standards for exceptional weatherability.

FINISH WARRANTIES

Pella offers a 10-year warranty on EnduraClad protective finish and a 20-year warranty on the EnduraClad Plus protective finish. See written warranties for complete details.

	Architect Series®	Designer Series®	Pella® ProLine	Fixed Frame Direct Set
EXTERIOR FINISH				
Aluminum cladding	●	●	●	●
Primed or unfinished wood	●	–	–	–
EXTERIOR ALUMINUM CLADDING COLORS / COATINGS				
EnduraClad® Exterior finish- three standard colors	●	●	●	●
EnduraClad Exterior finish- feature colors	●	●	●	●
EnduraClad Exterior finish- custom colors	●	●	–	●
EnduraClad Plus protective finish with - (70% fluoropolymer resin)	●	●	–	●

(1) Contact your local Pella sales representative for current color options. ProLine has limited feature colors, see each product section in Volume 2 for specific information.

(2) For custom colors, supply your architectural consultant with a 1" x 1" minimum color sample.